

Mitutoyo

Mitutoyo  Quality

Ultra-high Accuracy CNC Vision Measuring System QUICK VISION ULTRA

Vision Measuring Systems



Catalog No.E14002

The ultimate Vision Measuring System with best-in-class speed and accuracy

Advanced Technologies Supporting Ultra High-accuracy Systems

Optimal Structural Design through FEM Analysis

Structural design is optimized through the use of infinite element method (FEM) analysis. This results in maximum rigidity for minimum weight, minimizing deformations due to loading and guaranteeing excellent geometrical accuracy at all times.

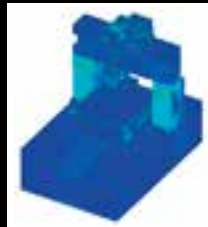

Self-suction Air Pad

If a normal air pad is used for the Y axis, it is necessary to increase the mass of the work stage to obtain appropriate rigidity. QV ULTRA (Quick Vision) employs a special air pad called a self-suction type that floats the air pad with compressed air and also generates an absorption power with a vacuum zone provided under negative pressure at the center of the pad. This achieves greater Y-axis rigidity and stage weight reduction concurrently, thus enabling stable stage drive.

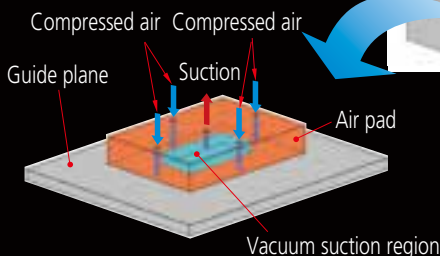
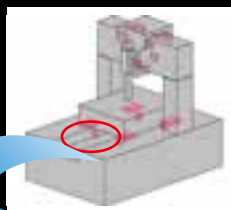

Temperature Compensation Function

The thermometer unit installed in the main body reads temperatures at each axis and calculates the amount of expansion and contraction of the body to compensate the measuring accuracy. This function allows the accuracy to be guaranteed in a wide range of 19 to 24°C. Additionally, the thermometer unit measures workpiece temperatures with two sensors in real time, outputting the results in which dimensions are converted to those at 20°C.

Main Body Structure Appropriate for High-accuracy Systems

The moving structure of a fixed bridge table employed for QV ULTRA makes the X axis and Y axis completely independent of each other, providing the feature that the moving accuracy of each axis is not easily affected by the other. The X-axis and Y-axis guides are made of granite for excellent abrasion resistance and thermal stability.

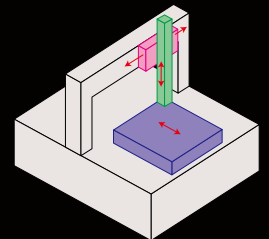

Ball Screw Floating Mechanism

QV ULTRA employs high-reliability ball screws in the floating mechanism. This floating mechanism will minimize the error due to axial fluctuation that adversely affects kinetic performance such as straightness and improve the driving speed.

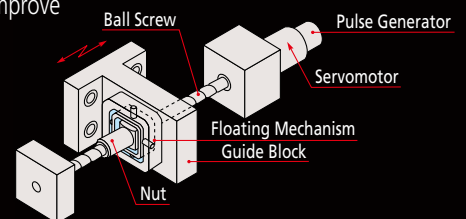

High-accuracy, High-resolution Scale

The length measuring systems, standard for individual axes, are equipped with a high-resolution linear encoder system with a resolution of 0.01µm, respectively, which was uniquely developed by Mitutoyo. This scale uses crystal glass as its material, of which the thermal expansion coefficient equals nearly zero, to minimize the scale expansion and contraction due to change in temperature and offer higher reliability measurement data.

Air Server

To avoid the adverse effect of supplied air temperature on the measuring system structure, the air server supplies air always maintained at a constant temperature.





QUICK VISION ULTRA

Tracking Auto Focus (TAF)

The TAF feature focuses continuously, adjusting to changes in the height of the object being measured. Automatic tracking of surface waves and warpage (in the Z axis height direction) improves measurement throughput. The feature also eliminates the hassle of focusing during manual measurement.

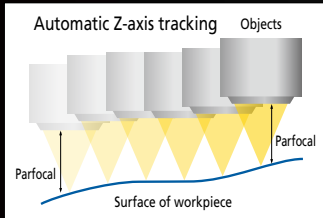

Note: Continuous measurement of displacement is not available.

Laser source	Semiconductor laser (peak wavelength: 690nm)				
Laser safety	Class2 (JIS C6802:2014, EN/IEC60825-1:2014+A11:2021)				
Auto-focus principle	Objective coaxial autofocusing (knife-edge method)				
Applicable objectives	QV-HR1x	QV-SL1x	QV-HR2.5x	QV-SL2.5x	QV-5x
Tracking range*	6.3 mm (±3.15 mm)	6.3 mm (±3.15 mm)	1 mm (±0.5 mm)	1 mm (±0.5 mm)	0.25 mm (±0.125 mm)

* When performing a tracking range, please set the upper and lower software limit to prevent collision with workpieces. Tracking range differs depending on the surface texture and reflection ratio.



PERFORMANCE

High-performance image auto focus

The image auto focus of QUICK VISION can measure the height of mirror-finished to rough surfaces, such as machined surfaces and plastic molded parts, with high accuracy and at high speed under any condition.

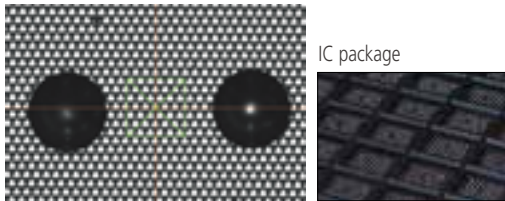

Pattern focus

By projecting a pattern through the optical path, auto focus can be applied to even surfaces on which it is difficult to obtain contrast, such as glass surfaces, film surfaces, and mirror-finished surfaces used widely for semiconductor parts.

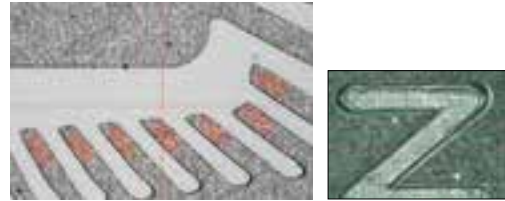

Multi-point auto focus

Multi-point auto focus can be used to set multiple focus positions, sizes, and angles to independent locations. This tool can be used to obtain multiple sets of height information with a single focus operation, which makes it possible to perform highly efficient height and flatness measurements.

Highly Functional Illumination Unit

- QUICK VISION uses LEDs for all of its light sources: coaxial, stage, and programmable ring light.
- Lighting uniformity has been achieved at a high level, which leads to excellent part program compatibility between multiple QUICK VISION machines.
- LED light sources have excellent responsiveness, which improves measurement throughput.
- LED light sources have longer life spans than halogen types, which reduces illumination fluctuations and thereby minimizes any errors caused by changes in light intensity.



Vertical coaxial light

Programmable ring light

Stage light

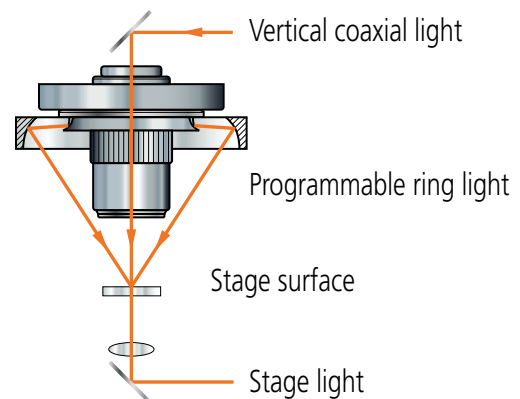

Programmable Ring Light (PRL)

Changing the positions of the two curved mirrors sets the ring light's direction to any chosen value between 30° and 80°. This is effective for enhancing the edges of inclined surfaces or very small steps. Furthermore, the PRL light's illumination can be controlled independently in every direction, front and back, right and left. This makes it possible to configure highly variable lighting settings to match measurement locations.

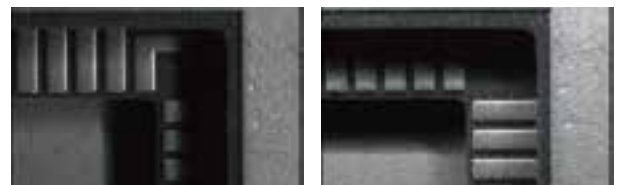

Programmable Power Turret

QUICK VISION's programmable power turret has excellent magnification repeatability which makes it suited for highly accurate measurements.

The standard specification permits three steps of magnification: 1x, 2x and 6x*.

The rich lineup of objectives includes lenses with magnifications ranging from 0.5x to 25x, which makes it possible to select the optimal optical system to match the measurement target. It is possible to install additional objectives after purchase of the main unit.

* Also available as special options: three or four steps of magnification: 1x, 2x, 4x and 6x.

Digital Magnification NEW

Four-step magnification can be obtained, namely 1x, 2x, 6x and with a new 12x digital magnification. As a special option, six-step magnification is available with 1x, 2x, 4x, 6x and new 8x and 12x digital magnification.

When using QV-HR2.5x

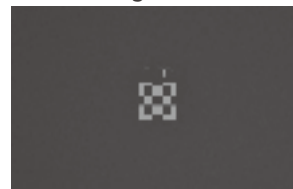

Turret 1x Field of view: 2.49 × 1.86 mm



Turret 2x Field of view: 1.24 × 0.93 mm



Turret 6x Field of view: 0.41 × 0.31 mm



Digital magnification 12x Field of view: 0.20 × 0.15 mm

SOFTWARE

QVPAK

The X, Y, and Z position data is detected from the measurement data gathered by the QUICK VISION system and the arithmetic processing of coordinates and dimensions is performed immediately.

Examples of computational capabilities

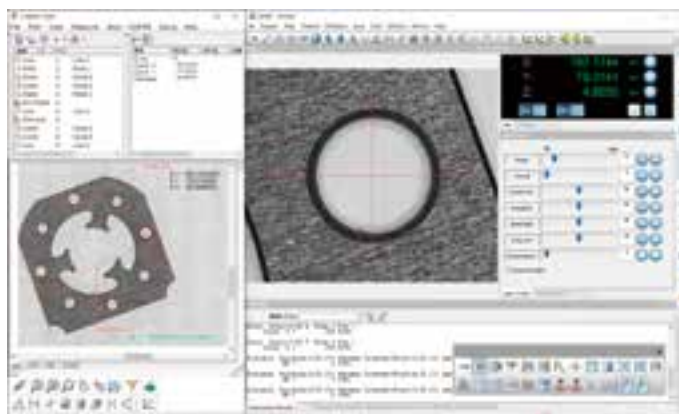
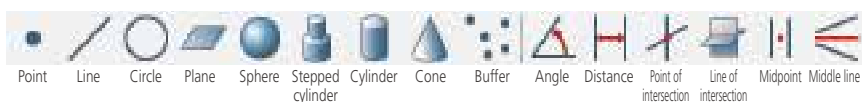

OPTIONAL SOFTWARE

FORMTRACEPAK-AP

Form Evaluation and Analysis Software

Contour Tolerancing Function

- Design data creation
CAD data conversion, master workpiece conversion, function specification, text file conversion, and aspherical surface design value creation
- Tolerancing
Normal vector direction tolerancing, axial direction tolerancing, and best-fit tolerancing
- Result display
Result listing, error graph, error developed view, error coordinate value display function, analysis result display

Microscopic Form Analysis

- Analyzed items: point measurement, line measurement, circle measurement, distance measurement, intersection measurement, angle measurement, origin setting, and axial rotation
- Calculated items: maximum, minimum, average, standard deviation, and area

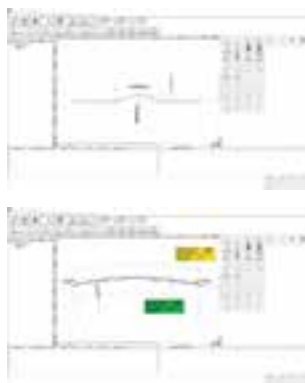

Report Creation Function

- Measurement result, error graph, and error developed view

Other Functions

- Recording and executing analysis procedures
- External output function: CSV, text or DXF/IGES format output
- Fairing process
- Quadratic curve fitting function
- Quasi-roughness analysis function



QV3DCAD

QV3DCAD creates a QVPAK part program from a 3D CAD model.

The current version supports two modes: the online mode that allows you to teach while monitoring the actual workpiece by synchronizing the software with the QV system, and the offline mode that allows you to create a part program on a PC not connected to the main unit.

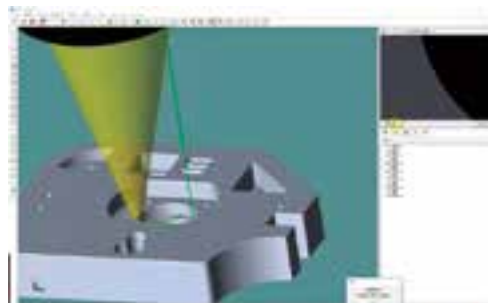

Offline teaching mode



Online teaching mode

PFF (Points From Focus) function

Scanning the object by auto focusing the objective can capture multiple cross-section images (image contrasts) at different heights. Thus obtaining 3D shape data from such images. The Z-axis repeatability is guaranteed by Mitutoyo's inspection method, so highly-accurate shape measurement can be performed.

PFF principle

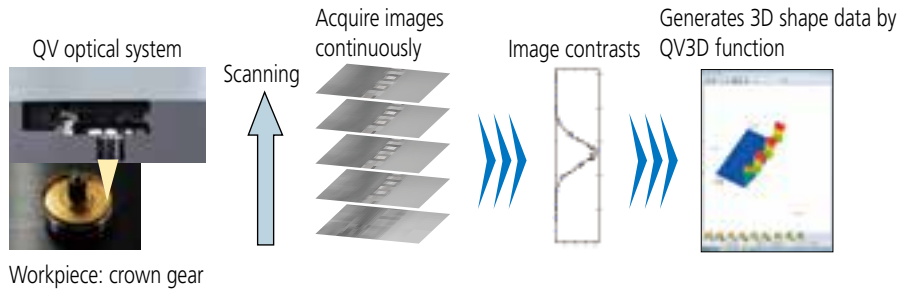

Measurement performance of PFF

The Z-direction repeatability is guaranteed by our inspection method.

	QV ULTRA
Repeatability (Z axis)	$2\sigma \leq 0.7 \mu\text{m}$
Accuracy-guaranteed Optical magnification	QV-5x + PT2x

Note: When using PFF function, please purchase QV3DPAK and the objective for PFF (please contact us for details).

Example of measurement with PFF

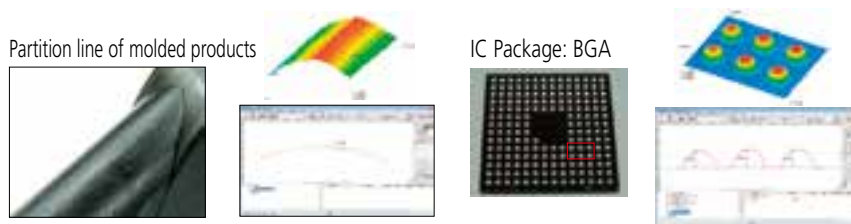

OPTIONS



QV Objectives

Objective	QV-SL0.5x ^{*1}	QV-HR1x	QV-SL1x	QV-HR2.5x	QV-SL2.5x	QV-HR5x	QV-5x	QV-HR10x ^{*1}	QV-10x ^{*1}	QV-25x ^{*1}
Code No.	02AKT199	02AKT250	02ALA150	02AKT300	02ALA170	02AWD010	02ALA420	02AKT650	02ALG010	02ALG020
Set of objectives that support PFF	-	-	-	02AKX895B	-	02AXA915B	02AKX900B	02AKX905B	-	02AKX910B
Working distance [mm]	30.5	40.6	52.5	40.6	60.0	20.0	33.5	20.0	30.5	13.0
Field of view [mm] ^{*2} (H)×(V)	Turret 1x	12.54x9.4	6.27x4.7	2.49x1.86	1.24x0.93	0.62x0.47	0.25x0.18			
	Turret 2x	6.27x4.7	3.13x2.35	1.24x0.93	0.62x0.47	0.31x0.23	0.12x0.09			
	Turret 6x	2.09x1.56	1.04x0.78	0.41x0.31	0.20x0.15	0.10x0.07	0.04x0.03			
	Digital magnificationq 12x	1.04x0.78	0.52x0.39	0.20x0.15	0.10x0.07	0.05x0.03	0.02x0.01			

*1 When the QV-SL0.5x, QV-HR10x, QV-10x, or QV-25x objective is used, some limitations, such as the illumination being insufficient depending on the workpiece, may occur.

*2 The values for field of view are not guaranteed values, but representative values.

Calibration chart

A calibration chart is used to compensate for the pixel size of the camera imaging chip and for the auto focus accuracy and optical axis offset at each magnification of the variable magnification unit (PPT).



Note: There are limitations on the function, depending on the lens.
For details, contact your Mitutoyo sales office.

QV compensation chart

This glass chart is used to perform compensation for distortions within the screen caused by the optical system, and auto focus compensation, which reduces auto focus variations that are caused by differences between the workpiece pattern and texture



Note: There are limitations on the function, depending on the lens.
For details, contact your Mitutoyo sales office.

LINE-UP



QV-U404P1L-E

Specifications

Model name		QV ULTRA	
Model code		QV-U404P1L-E	QV-U404T1L-E
Main unit			
Measuring range (X×Y×Z) [mm]		400×400×200	
External dimensions (W×D×H) (Including dedicated stand) [mm]		1172×1736×1910	
Stage glass (W×D) [mm]		493×551	
Main unit mass (Including dedicated stand) [kg]		2150	
Vision measuring accuracy [μm]*1	Vision	EUX / EUY, MPE	① (0.35 + 1.3L / 1000) / ② (0.35 + 1.8L / 1000)
		EUXY, MPE	① (0.5 + 2L / 1000) / ② (0.5 + 2.5L / 1000)
	Optical magnification	EUZ, MPE	① (1.5 + 2L / 1000) / ② (1.5 + 3.5L / 1000)
Resolution of scale [μm]		0.01	
Operating temperature	Ambient temperature*2	① 20±2 °C / ② 19 to 24 °C	
	Temperature variation	0.5 °C/ 1H and 1 °C/ 24H	
Maximum stage loading [kg]*3		40	
Imaging device		B&W CMOS digital camera	
Illumination unit	Stage light	White LED	
	Coaxial light	White LED	
	PRL	White LED	
Observation unit*4		Programmable power turret 1x, 2x, 6x, (12x)*5	
Tracking Auto Focus device		-	✓
Air supply	Pressure	0.4 MPa*6	
	Required air flow rate	300 L/min (ANR)	
Thermal compensation function		Automatic	

*1 L: arbitrary measuring length (unit: mm)

*2 The guaranteed accuracy depends on ambient temperature.

*3 An excessively biased or concentrated load is excluded.

*4 Programmable power turret 1x, 2x, 4x, 6x model is available by special order. Digital magnification function allows 8x and 12x in addition to 1x, 2x, 4x, 6x. 6 steps of magnification are available in total.

*5 The value in parenthesis is for digital magnification change.

*6 Air supply pressure to be in range 0.5 to 0.9 MPa.

Dimensions

unit: mm

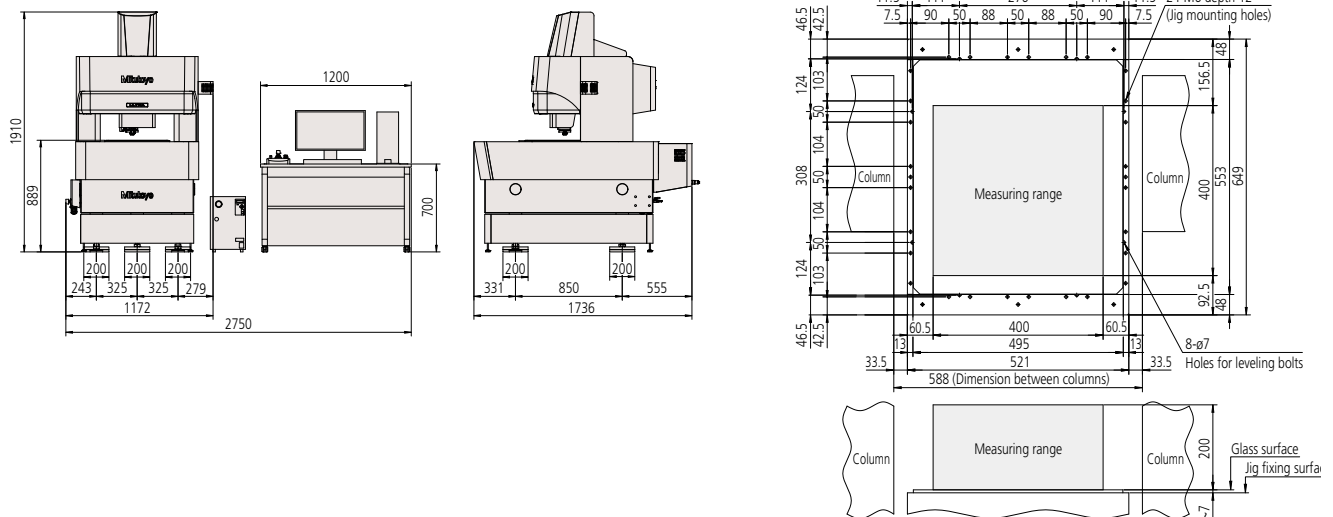

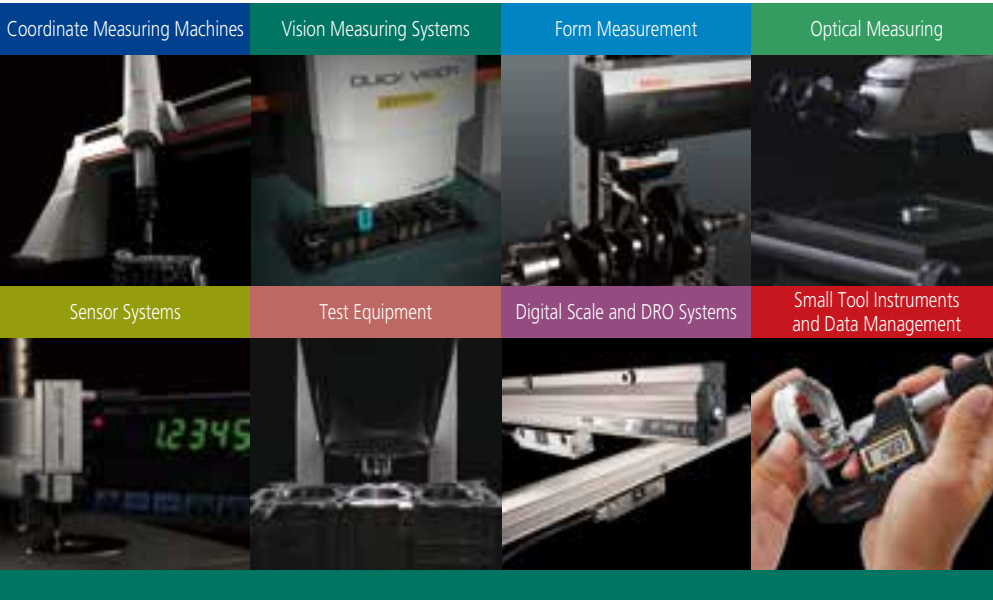

Whatever your challenges are, Mitutoyo supports you from start to finish.

Mitutoyo is not only a manufacturer of top quality measuring products but one that also offers qualified support for the lifetime of the equipment, backed up by comprehensive services that ensure your staff can make the very best use of the investment.

Apart from the basics of calibration and repair, Mitutoyo offers product and metrology training, as well as IT support for the sophisticated software used in modern measuring technology. We can also design, build, test and deliver measuring solutions and even, if deemed cost-effective, take your critical measurement challenges in-house on a sub-contract basis.



Find additional product literature and our product catalogue

<https://www.mitutoyo.co.jp/global.html>

Our products are classified as regulated items under Japanese Foreign Exchange and Foreign Trade Law. Please consult us in advance if you wish to export our products to any other country. If the purchased product is exported, even though it is not a regulated item (Catch-All controls item), the customer service available for that product may be affected. If you have any questions, please consult your local Mitutoyo sales office.

Note: Product illustrations are without obligation. Product descriptions, in particular any and all technical specifications, are only binding when explicitly agreed upon.
MITUTOYO and MICAT are either registered trademarks or trademarks of Mitutoyo Corp. in Japan and/or other countries/regions. Other product, company and brand names mentioned herein are for identification purposes only and may be the trademarks of their respective holders.
All product information contained in this brochure is current as of July 2023.

Mitutoyo

Mitutoyo Corporation

20-1, Sakado 1-Chome,
Takatsu-ku, Kawasaki-shi,
Kanagawa 213-8533, Japan
T +81 (0) 44 813-8230
F +81 (0) 44 813-8231
<https://www.mitutoyo.co.jp>